

REFERENCE JUNCTION TEMPERATURE COMPENSATOR

CHINO
PS
PERFORMANCE SPECIFICATION

ELECTRIC TYPE

- MODEL TO-□ (High precision type)
 TN-□ (General purpose type)
 HT □□□ - □□ (Multi-point type)

ICE COOLED TYPE

- MODEL UN-□□□

It is necessary for measuring temperature using a thermocouple to keep the reference junction temperature constant or compensate for the reference junction temperature.

The reference junction temperature compensator comprises the compensation type which compensates for the reference junction temperature by generating a thermoelectromotive force corresponding to the reference junction temperature by an electric circuit, and the cooling type which dips one end of thermocouple into ice to obtain 0°C. The thermoelectric thermometer is generally provided with a reference junction temperature compensation circuit. However, when the thermoelectromotive force is measured by using a mV meter or a potentiometer, or when a performance test of the thermoelectric thermometer is done, the reference junction temperature compensator is needed.

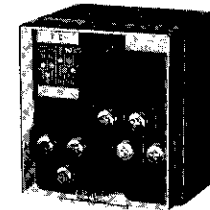

MODEL TO, TN

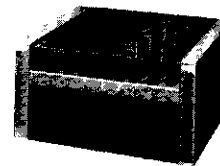

6 points

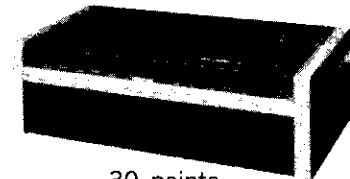

30 points

MODEL HT



1 point



6 points

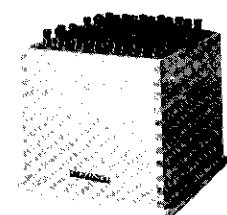

12 points

MODEL UN

● MODEL TO, TH

A temperature sensing resistor is inserted into the bridge circuit to generate a thermoelectromotive force corresponding to the reference junction temperature. Both Models TO and TN are used for one point, but the Model TO is of a high-precision type.

● MODEL HT

The principle of this model is the same as in Models TO and TN. It comprises two types ; one applies to 6 points, while the other applies to 30 points.

High-precision calibrator specifications are prepared for calibrating thermocouples in respective types.

● MODEL UN

This model is designed to keep the reference junction temperature constant at 0°C by putting small pieces of ice into a Dewar's bottle.

■ SPECIFICATIONS BY MODELS

Type		TO	TN	H T		HT□□□-□K		U N		
No. of points		1	1	6	30	6	30	1	2,3,6	12
Reference temperature		0°C	0°C	0°C		0°C		0°C		
Accuracy		±0.5 or ±1.0°C (R)	±2°C	±0.5°C		±0.2°C		—		
Compensation temperature range		(-10~60°C	(-10~60°C	(-10~60°C		18~28°C		—		
Power supply		Required		Required		Required		Not required		
Type of thermocouple	R	○	○	○	○	○	○	○	○	○
	S	○	○	○	○	○	○	○	○	○
	K	○	○	○	○	○	○	○	○	○
	E	○	○	○	○	○	○	○	○	○
	J	○	○	○	○	○	○	○	○	○
T	○	○	○	○	○	○	○	○	○	○

CHINO
CHINO WORKS, LTD.

RJ-PS-83-IB

ELECTRIC REFERENCE JUNCTION TEMPERATURE COMPENSATOR

- MODEL TO- (High precision type)
 TN- (General purpose type)

The Models TO and TN are not of a cooling type which keeps the reference junction constant at 0°C by cooling one end of thermocouple, but they are a compensation type which generates a thermoelectromotive force corresponding to the reference junction temperature (terminal temperature of this instrument) by an electric circuit.

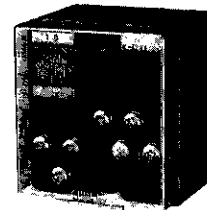

MODEL TO, TN

- This instrument is characterized by easy handling, a compact and lightweight structure, and a short preheating time, as compared with cooling type instrument.
- This new compensating system ensures a wide compensating range and high accuracy (Model TO, in particular).

■ PRINCIPLE

Temperature compensation resistors MR are inserted in all sides of the bridge. Their resistance values change as temperature changes.

A bridge current is converted into a constant current through zenor diode ZD and transistor Tr, and the current value is controlled by VR1. Thus, this instrument generates a potential difference corresponding to its terminal temperature.

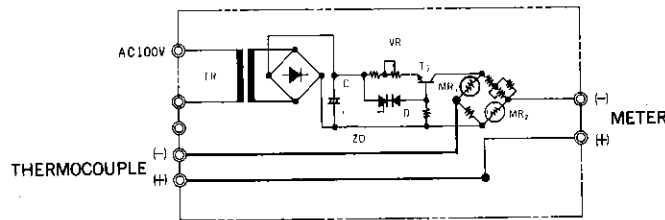

■ MODEL

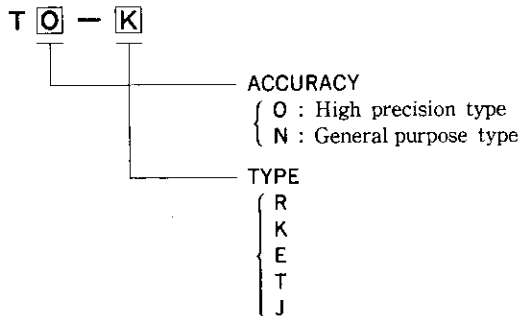

■ **GENERAL SPECIFICATIONS**

NO. OF POINTS	: 1
TYPES	: R, K, E, T, J 5 types*
REFERENCE TEMPERATURE	: 0°C
COMPENSATING TEMPERATURE RANGE	: (-)10 ~ 60°C
ACCURACY	: TO — ±0.5°C (R : ±1°C) TN — ±2.0°C
PREHEATING TIME	: 3 min.
INTERNAL RESISTANCE	: TO — About 10 Ω TN — About 6 Ω
VOLTAGE FLUCTUATIONS	: ±10% of rated value
POWER SUPPLY	: 100V AC, 50/60Hz
WEIGHT	: About 250 g

* Instruments for tungsten-rhenium 5.26 and iron-gold-cobalt¹ are prepared for Model TO only at option.

■ **TERMINAL BOARD**

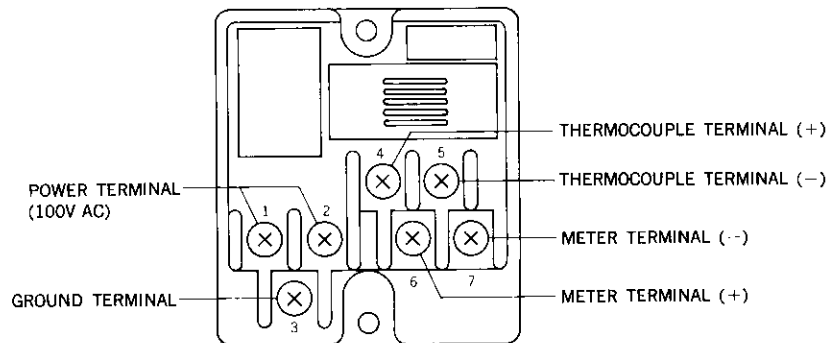

■ **EXTERNAL DIMENSIONS**

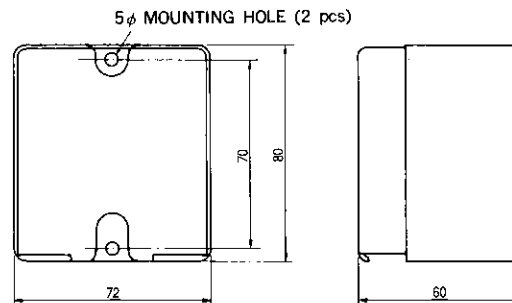

Unit : mm

MODEL HT □□□-□□

This instrument is of a 6-point type or a 30-point type corresponding to TO. It comprises 3 types according to its mounting profiles. In addition to the general type, a calibrator specification type is also available, and this type is suitable for calibrating thermocouples.

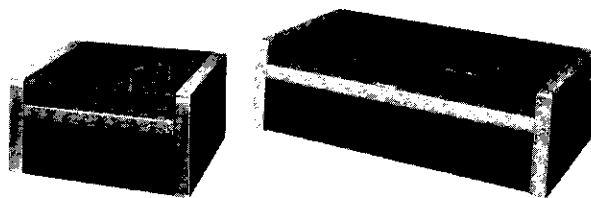

MODEL HT-06K-D

MODEL HT-30K-D

■ **MODEL**

HT □ □ □ - □ □

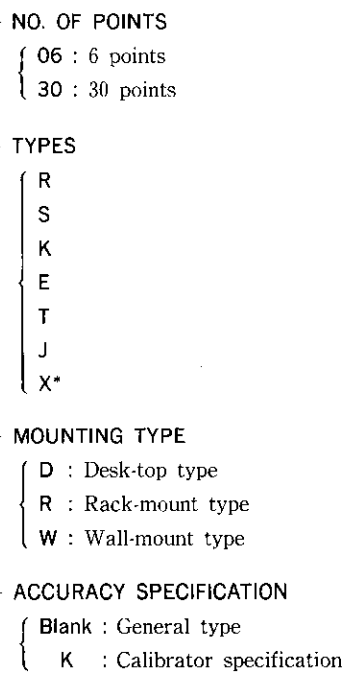

*Instrument for thermocouple, tungsten-rhenium 5.25 is also available at option. Thermocouples R and K are combinable with each other. However, if two or more types of thermocouples are combined, their combinations are limited up to 3 types, so that measuring points are 2 or more per type in case of the 6-point type, and 10 or more per type in case of the 30-point type.

■ GENERAL SPECIFICATIONS

NO. OF POINTS	: 6 points, 30 points, 2 types
TYPES	: R, S, K, E, J, T 6 types*
REFERENCE TEMPERATURE	: 0°C
COMPENSATING TEMPERATURE RANGE	: HT --- (-) 10~60°C HT-□□□-□K --- 18~28°C
ACCURACY	: HT --- ±0.5°C HT-□□□-□K --- ±0.2°C
PREHEATING TIME	: 3 min.
INTERNAL RESISTANCE	: About 3 min.
INSULATION RESISTANCE	: 500V DC, 20MΩ or higher between wires of thermocouple, and also between each wire and ground terminal. 1000V DC, 20MΩ or higher between power terminal and ground terminal
MOUNTING TYPE	: Desk-top type, rack-mount type, or wall-mount type
POWER SUPPLY	: 100V AC, 50/60Hz
ALLOWABLE VOLTAGE FLUCTUATIONS	: (-)10~10% of rated value
POWER CONSUMPTION	: 6 points --- About 1VA 30 points --- About 4VA
WEIGHT	: 6 points --- About 2.5kg 30 points --- About 5kg

*Instruments for tungsten-rhenium 5.26, iron-gold-cobalt are also available at option.

■ TERMINAL BOARD

● 6 points

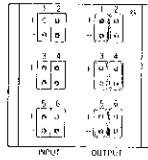

● 30 points



Note) Output terminals are side-face connectors.

■ EXTERNAL DIMENSIONS

● DESK-TOP TYPE

6 points

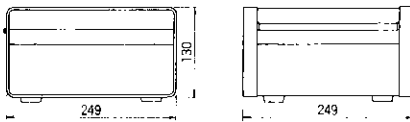

30 points

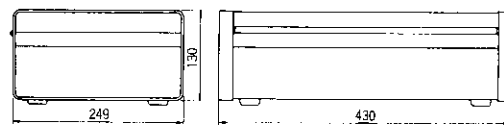

● WALL-MOUNT TYPE

6 points

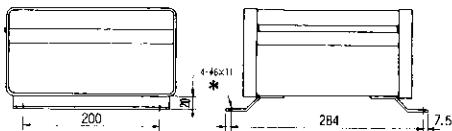

30 points

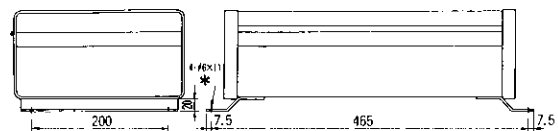

● RACK-MOUNT TYPE

6 points

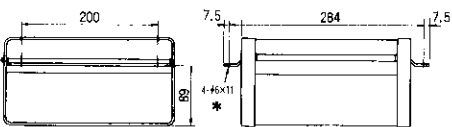

30 points

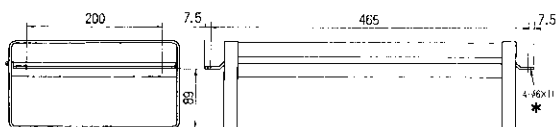

* : Long hole

ICE-COOLED REFERENCE JUNCTION TEMPERATURE COMPENSATOR

MODEL UN-□□□

The Model UN is of an ice-cooled type reference junction temperature compensator, which keeps a reference junction temperature at 0°C by putting one end of a thermocouple put into glass tubes into a Dewar's vessel filled with chipped ice. The instrument consists of a terminal section and cooling section, and a wooden box for supporting the terminal board is provided only for the multi-point type.



DEWAR'S VESSEL*



UN-01

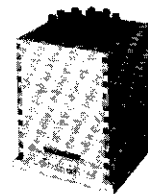

UN-06

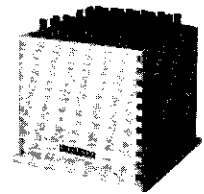

UN-12

■ FEATURES

- The thermocouple is put into a glass tube and its tip is filled with silicon grease, thus ensuring high thermal conductivity and stability.
- Temperature in ice can be checked by inserting the attached bar mercury thermometer into the test thermometer insertion hole located at the center of the terminal board.

■ SPECIFICATIONS

NUMBER OF POINTS : 1, 2, 3, 6, (12), 5 types
 However, 12 points are only for K or T.
 TYPES : R, K, E, T, J, 5 types

■ MODELS

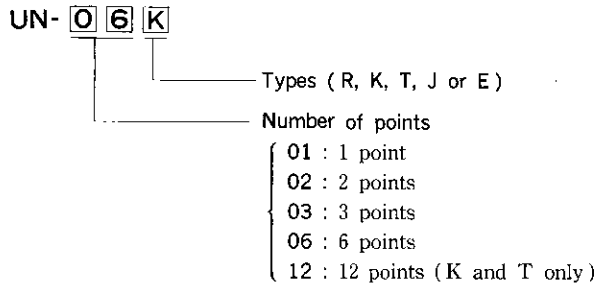

■ CONSTRUCTION

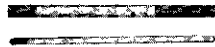
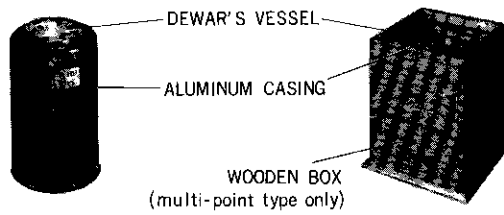
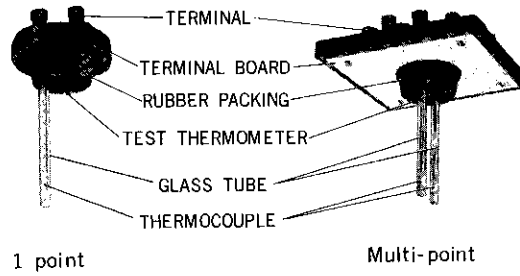

Bar mercury thermometer*

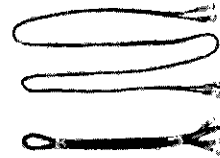

Connection cord

* The Dewar's vessel and bar mercury thermometer are also available as unit parts.

■ **TERMINAL BOARD**

● UN-01

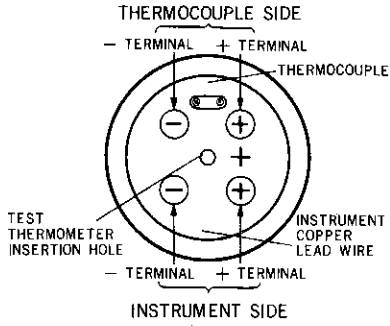

● UN-02

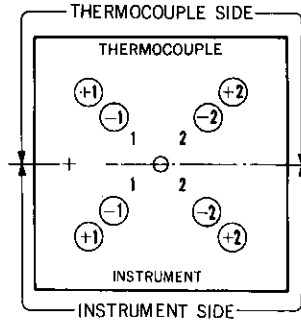

● UN-03

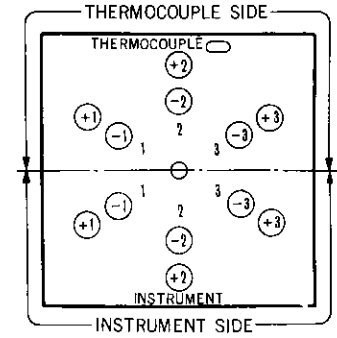

● UN-06

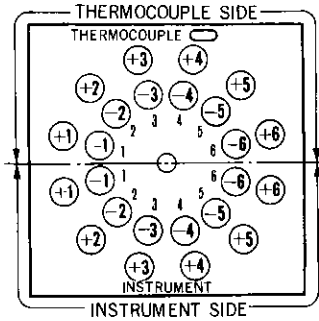

● UN-12

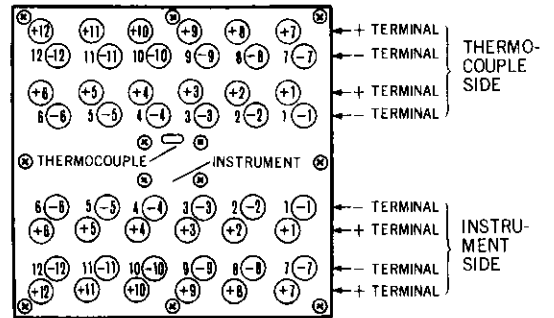

■ **EXTERNAL DIMENSIONS**

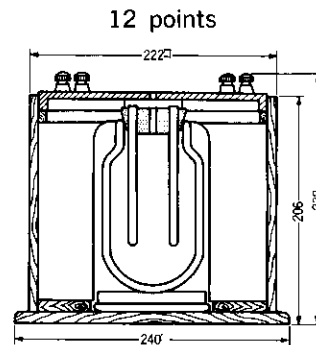
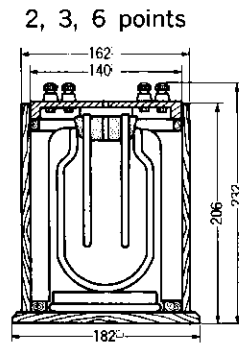
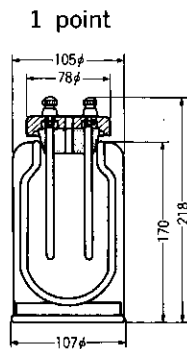

Unit : mm

■ **EXAMPLE OF WIRING**

○ When the standard electromotive force of a thermocouple is found :

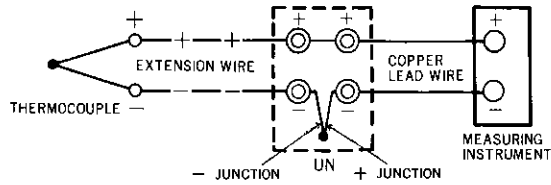

○ When a thermocouple type thermometer with a temperature compensator is checked and calibrated :

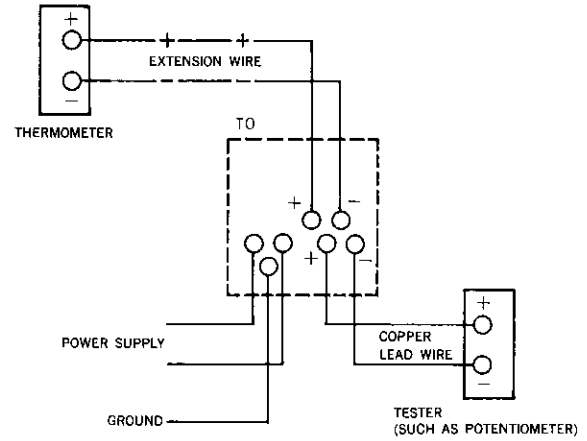
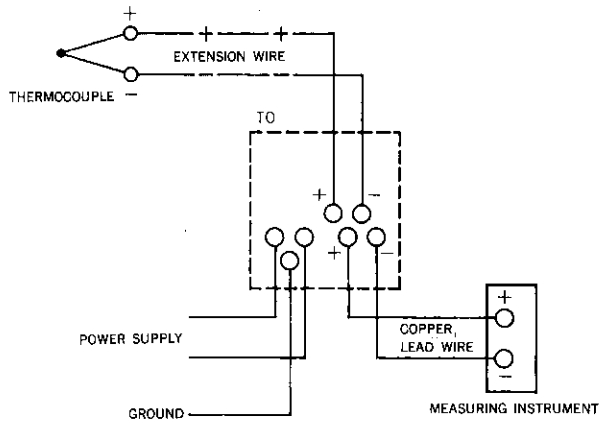
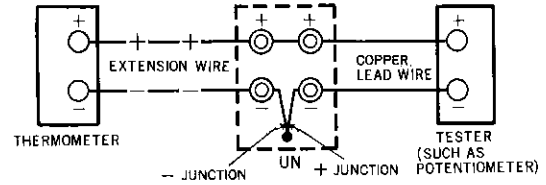

■ **ACCESSORIES (Model : UN)**

ACCESSORIES : Bar mercury thermometer ($-3 \sim +3^{\circ}\text{C}$) — 1 pc.
 Connection cord (approx. 1m) — Same as the number of points.

CHINO CORPORATION

32-8, KUMANO-CHO, ITABASHI-KU, TOKYO 173

Tel : 03-3956-2171

Facsimile : 03-3956-0915

Telex : 272-2044 CHINO J