

KR2-H series

High performance Graphic recorder



KR2-H Series are advanced touch screen display (keyless) paperless Graphic Recorder with high performance and high operating function along with high visibility 5.7" TFT color LCD display. Universal input with high speed of sampling rate approx. 1s/All points (approx. 100ms / 4 points) and high accuracy rating of $\pm 0.1\%$ FS have been realized. Measured data is stored into internal memory and SD card up to 32GB. It can be monitored by a web browser screen on the multiple computers via intranet or internet, and FTP transfer of the data file and E-mail notification are also available.



*Screen is a framed composite image.

■ FEATURES

● Improved processing speed.

Processing speed has been improved (Compared to conventional products), and Screen scrolling, calculations, PDF output (PDF chart specification only) etc. became faster.

● PDF file output of chart is available. (PDF chart specification only)
100mm width chart is created in pdf format and can be printed in the same size as the chart paper.

● Easy to store, search, and share chart paper (PDF chart specification only).
Electronic data and PDF charts can be automatically stored on a server or on the cloud, making it easy to access detailed data when needed.

● Clear 5.7-inch TFT color LCD display
A variety of display functions are installed on a display with excellent visibility. In addition to real-time/historical trend display, bar graph display and numerical display can be selected according to the application.

● Large memory capacity and various recording methods
An SD card slot is standard as an external memory. It is capable of recording a large capacity data up to 32GB. You can select a variety of data storage methods, such as schedule recording by day of the week or date and time, recording start by external signal or event, and data recording before and after trigger points such as alarms.

● Stable recording of multiple points with high accuracy and high speed
Achieves high-speed acquisition of approximately 1 s/all points (approx. 100 ms/4 points) and high accuracy of $\pm 0.1\%$ FS. Stable measurement and recording can be performed even at high speeds. The withstand voltage between the input channels is 1000 V AC (excluding the input of the resistance temperature detector), which is a high withstand voltage.

● Direct writing on the screen
With attached touch pen, comments can be written on the chart.

● USB port on the front
Data saved in the SD card can be extracted to the USB memory stick (max. 8GB USB memory stick) by plugging it into the port.

● LAN network support
By using Ethernet, it is possible to build a system that matches the network environment with a variety of functions such as remote monitoring with a browser, FTP server, and e-mail reporting.

● Application software (TRAMS) for analysis and data acquisition
Easy play back and editing data files collected by the recorder.

■ MODELS

KR2□□PH□□□-□□□

Type

S:Standard
D:PDF Chart specification

Measurement point/sampling rate

6:6 points / 1 sec.
2:12points / 1sec.

Communication interface

G:Ethernet+Low/high order communications
RS485(Standard)
E:Ethernet
B:Ethernet+low order communications *1,*2
N:None

Alarm output, Contact input (option)

0:None
2:Mechanical relay output (4points'c'contact)
7:Digital input (4points)
8:Mechanical relay output (2points 'c' contact)
+Digital input (2 points)

Installation type

A:Panel mounting type
T:Portable type
(Grip and rubber feet attached) *2

Others(Option)

NNN:None
1NN :Custom graphic screen
2NN :High Accuracy Temperature Converter KT-M input *3,*5
3NN : Custom graphic screen
+High Accuracy Temperature Converter KT-M input *3,*5
N1N :Barcode reader specifications*2,*4
(Barcode reader is sold separately)
N2N :Barcode recipe specifications*3
(Barcode reader/others are sold separately)
NNP:Past profile reply

*1 Barcode Reader Specification (RS-232C D-Sub9Pin)

*2 Does not comply with CE and UKCA

*3 Only communication interface (option) G can be selected.

*4 Only communication interface (option) B can be selected.

*5 Can be selected only when 1st digit is 2 or 3 and second digit in N.

KR2-H series

Screens

Real time trend screen

Real time trend display of selected group.
Vertical or horizontal trend can be displayed.

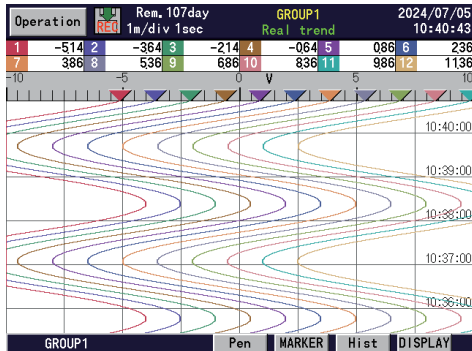

Bar Graph Screen

Bar graph of selected group can be displayed.
Vertical or horizontal bar graph can be displayed.

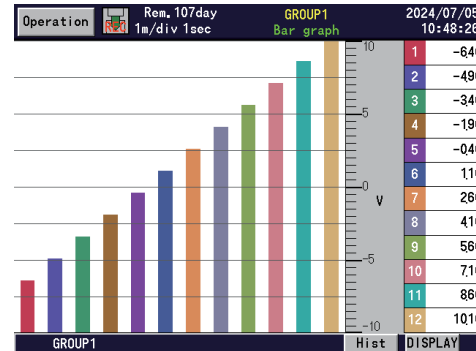

Numerical display

Measured data and alarm status of selected group can be displayed simultaneously.

Channel	Value	Channel	Value	Channel	Value
CH1	-5.23	CH2	-3.73	CH3	-2.23
CH4	-0.73	CH5	0.77	CH6	2.27
CH7	3.77	CH8	5.27	CH9	6.77
CH10	8.27	CH11	9.77	CH12	11.27

Dual trend screen

2 split display for real time trend and historical trend.
Historical trend can be scrolled.

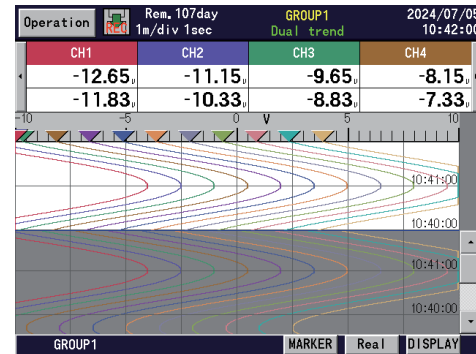

Information display

Activation time	Cancel time	CH	Type
03/12 10:43:41	03/18 16:37:35	CH1	AL4 Upper
03/12 10:43:41	07/05 10:12:49	CH1	AL3 Upper
03/12 10:43:41	03/18 16:37:35	CH1	AL2 Upper
03/12 10:43:41	07/05 10:12:49	CH1	AL1 Upper
03/11 16:00:05	03/11 16:01:37	CH1	AL4 Upper
03/11 16:00:05	03/11 16:01:37	CH1	AL2 Upper
03/06 08:43:03	03/11 16:01:37	CH1	AL3 Upper
03/06 08:43:03	03/11 16:01:37	CH1	AL1 Upper
03/06 08:42:41	03/06 08:43:04	CH1	AL4 Upper
03/06 08:42:41	03/06 08:43:04	CH1	AL2 Upper
02/29 09:13:12	03/06 08:42:42	CH1	AL3 Upper
02/29 09:13:12	03/06 08:42:42	CH1	AL1 Upper

Circular trend screen

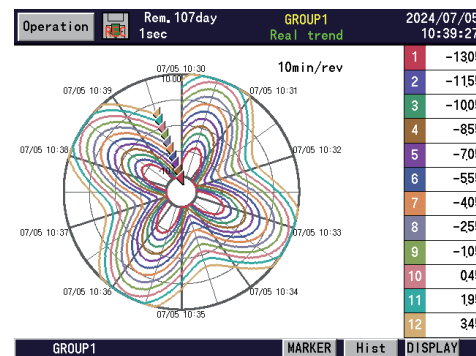

Writing using touch pen

Letters or illustrations can be directly written on the screen and can also be stored on recording screen.

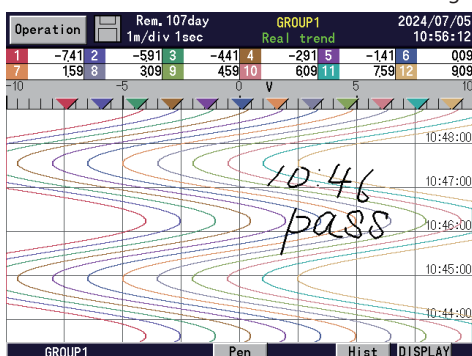

Lower order communication screen

MV and SV of our controllers connected at lower order can be displayed.

DB2000_1	DB2000_2
PV: 27.20	PV: 25.00
SV: 2.00	SV: 10.00
MV: 0.00	MV: 0.00
DB2000_3	
PV: 50.00	
SV: 25.00	
MV: 0.00	

Input Specifications

Measuring points: 6 Points, 12 Points
 Input types : Universal
 DC Voltage... $\pm 13.8\text{mV}$, $\pm 27.6\text{mV}$, $\pm 69.0\text{mV}$
 $\pm 200\text{mV}$, $\pm 500\text{mV}$, $\pm 2\text{V}$, $\pm 5\text{V} \pm 10\text{V}^*$, $\pm 20\text{V}^*$, $\pm 50\text{V}^*$
 (* With built in voltage dividing resistor)
 DC Current ... Can be used by using voltage dividing resistors (Sold separately)
 T/C ... B, R, S, K, E, J, T, N, PtRh40-PtRh20, W-WRe26,
 C (WRe5-WRe26), Platinel II, NiMo-Ni, CR-AuFe, U, L
 RTD... Pt100, JPt100, Pt50, Pt-Co
 Accuracy ratings: Refer to table of measurement range / accuracy rating
 Reference junction
 compensation accuracy: K, E, J, T, N, Platinel II
 $\dots \pm 0.5^\circ\text{C}$ or less (measurement input 0°C or above)
 R, S, W-WRe26, C (WRe5-WRe26), NiMo-Ni, CR-AuFe, U, L
 $\dots \pm 1.0^\circ\text{C}$ or less (measurement input 0°C or above)
 Measuring cycle: 1s / all channels (About 100ms/4 points)
 * If recording cycle is set as less than 0.5s the input channels automatically becomes as 4 channels and measurement cycle will be 100ms.

Burn out : Input signal disconnection detection for thermocouple and resistance thermometer inputs.
 UP/DOWN/NONE can be selected for each input
 Scaling : Range / Scale optional set up
 Digital filter : FIR filter
 Allowable signal
 source resistance: T/C input (With / Without Burn Out)
 And DC voltage input ($\pm 2\text{V}$ or less) ... $1\text{k}\Omega$ or less
 DC voltage input ($\pm 5\text{V}$ or less) ... $100\ \Omega$ or less
 RTD... $10\ \Omega$ or less per wire (equal for all 3 wires)
 Input resistance: DC voltage input, TC input... About $1\text{M}\Omega$
 Maximum input voltage: DC voltage input ($\pm 2\text{V}$ or less)
 And TC input (Burn out disabled) ... $\pm 10\text{VDC}$
 DC voltage input ($\pm 5\text{V} \sim \pm 50\text{V}$) ... $\pm 60\text{VDC}$
 Between channels: Between various channels 1000V AC or above
 Dielectric strength
 between channels: (High strength semiconductor relay used)
 (B terminal of resistance thermometer is shorted internally between channels)
 Common mode
 rejection ratio: 120dB or above
 Series mode
 rejection ratio: 50dB or above

Recording specifications

Internal memory: Flash memory (32MB)
 External memory: SD card (Capacity up to 32GB) 512MB Standard attached
 \dots ATP Electronics and TDK Corporation made recommended
 USB memory
 \dots HAGIWARA Solutions Co., Ltd. made 8 GB recommended
 Recording cycle: 100, 200, 500ms (When only 4 points)
 1, 2, 3, 5, 10, 15, 20, 30s
 1, 2, 3, 5, 10, 15, 20, 30, 60 min
 Recording data: Measured data... File name (Group name), time day month
 and year of recording start, tag, measured data,
 alarm status / types, marker text
 Setting parameter... All parameters
 Storing types: Binary / CSV selectable
 Storing method: Manual start / stop
 Schedule (Day and time, date and time specification)
 Trigger signal (alarm event, digital input)
 Data recording of before and after trigger
 *Pre-trigger is selectable. Max 950 data.
 Recording group: 44 points / Up to 5 groups can be registered
 (Total max 100 points can be recorded)

Computation specifications

Computation points : Maximum 44 points
 Computation cycle : 100ms / all points
 Computation types : Arithmetic operations... Addition, subtraction, multiplication,
 division, remainder, power comparison
 Comparison operations... Equal, un equal, greater than, less than,
 Logical operations... AND, OR, XOR, NOT
 General functions... Round up, round down, absolute value,
 square root, exponent of e, natural logarithm,
 common logarithm,
 Totalization operations... analog integration, digital integration
 Channel data operations... Measured data computation,
 calculated data computation,
 Others ... Dew point, relative humidity, F-value,
 SD card remaining capacity, Moving average,
 wind direction (Display 16 directions)

Alarm specifications

Set up count : Up to 4 alarms can be programmed per channel
 Alarm types : Upper limit, lower limit, differential upper limit,
 differential lower limit (dead band is selectable), abnormal data
 Delay function : sett up range of alarm delay 0~3600s
 Alarm settings: AND/OR selectable
 Alarm output : Refer to option specifications

PDF Chart Specifications

By using PDF chart function, data can be saved as PDF file in to SD card
 as equivalent of data on CHINO's analog recorder or hybrid recorder chart paper.
 Output details: File information... Select from below, Information regarding the file
 is printed on the top of the file.
 Chart speed, Instrument name, Serial NO, Software version,
 Group name, Batch name, Lot NO, Batch text,
 Original data file name, channel parameters
 Lines ... Measured data is displayed in graph based on the display
 scale set in the channel parameters Color of lines
 on the chart is output as color set in channel parameter
 Data ... Data is printed regularly at the time set in Data interval print
 Scale channel NO. ... Prints channel NO, tag, and scale minimum /
 maximum at that time are printed
 Time line ... Printing is done by a cycle corresponding to
 the chart speed Start point of cycle is 00:00
 Output method: Auto output ... PDF chart of a whole file is created
 automatically at the file completion
 Output from internal memory file:
 \dots Output PDF chart from internal memory file
 by specifying the time range
 Output from external memory file:
 \dots Output PDF chart from external memory
 (SD card or USB memory) file by specifying the data range.
 Drawing settings: Chart speed
 \dots Chart length at 1 hour (or 1 minute)
 $\dots 100\text{mm}$
 Chart width
 Connection between dots ... [OFF] As dot printing type recorder,
 dotting is done on the point of the recording data.
 [ON] Connect intervals between dots
 to create a chart as pen type recorder
 Auto range ... Setting of auto range switching function
 if the data exceeds the range.
 Usually selected from none, normal, overlap.
 PDF file protection: None
 \dots Can be edited by Acrobat etc
 Normal
 \dots it does not allow 'Changing the document'
 and page extraction'.
 (Printing and signing) etc is possible
 Complete
 \dots All the editing functions are not allowed.
 Selection of Paper: Chart paper, A4, A3, letter
 (Output on chart paper in case of Auto)

Display specifications

Display: 5.7 inch TFT color LCD VGA (640x480 Dots)
 Display types: Measured data display (Trend display, numerical display,
 bar graph display, circular chart display)
 Historical trend display (Can be displayed along with real time trend)
 information display (alarm, marker list, file list) setting screen
 (alarm, computation, memory, system, maintenance, communication etc)
 Trend display : 12 color display
 Display groups Maximum 5 groups
 Display points Maximum 44 points per group
 Time axis direction Vertical Horizontal or circular
 Line thickness Can be selected from 1 to 5
 Scale display 4 Scales
 Tag, numerical value to be displayed or not, markers
 Data value display : Display groups Maximum 5 groups
 Display points Maximum 44 points per group
 Display details Measured value, Channel / tag, unit, alarm status
 Bar graph screen : 12 color selectable
 Display groups Maximum 5 groups
 Display points Maximum 44 points / group
 Display direction Vertical or horizontal
 Scale display 1 scale
 Information display : Alarm display (alarm activation / released history display)
 Device information (Model, Serial NO, options, others)
 LCD back light : Auto / Manual OFF function
 Brightness 4 levels adjustment

* LCD display may contain some pixels that always or
 never illuminate and the brightness of some areas of display may appear un even.
 These are typical LCD performance characteristics and do not constitute malfunctions.

KR2-H series

Communication function

Ethernet

- Media :Ethernet (10BASE-T/100BASE-TX)
- FTP Server :Data file can be read from network computer
- FTP Client :Transfer of data file to network server
- SNTP client :Time can be synchronized with the SNTP server on the network
- Web server :Conformed to HTTP1.0... Displays the alarm, information of maintenance by browser software (Microsoft Edge)
*Password can be set

- E - M a i l :E-mail notification at specified time for alarm activation
Report data at specified time is selectable from all registered data
Notification addresses Maximum 8 contacts

Connectivity

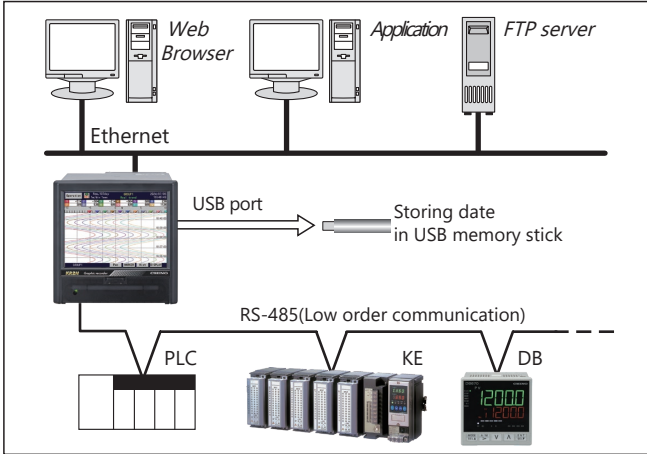

General specifications

- Rated power voltage:100-240V AC (universal power supply) 50/60Hz
- Maximum power consumption:35VA
- Reference operation condition:Ambient temperature 21 TO 25°C , 45~65%rh
Power voltage 100VAC±1.0%
Power frequency 50/60Hz±0.5%
Attitude Left / right 0°, forward/backward 0°
Warm up time Longer than 30 minutes
Display luminance 2
- Normal operating condition:Ambient temperature 0 to 50°C , 20 to 80%rh
Power voltage 90~264V AC
Power frequency 50/60Hz±2%
Attitude Left / right forward/backward 0°, Backward tilting 0°to 20°
Display luminance less than 2
- Transport condition :At the packed condition on shipment from factory
Ambient temperature -20 to 60°C,
Ambient humidity 5 to 90%rh (No dew condensation)
Vibration 10~60Hz 4.9m/s(2 0.5G) or less Shock 392m/s(2 40G) or less
- Storage conditions :Ambient temperature -20 to 60°C,
Ambient humidity 5 to 90%rh (No dew condensation)
- Power failure protection :FLASH memory and SRAM stores the settings
Data is stored in FLASH memory
Lithium battery backup the clock and parameter RAM for more than 5 years.
(with the condition as operations for 8 hours or more a day).
- Insulation resistance :Secondary terminals and protective conductor terminals 20MΩ or more at 500VDC
Primary and protective conductor terminals 20MΩ or more at 500VDC
However, Primary terminals : power terminals : (L,N), alarm output terminals
Secondary terminals : measuring input terminals, digital input terminals, communication terminals
- Dielectric strength :Secondary terminals and protective conductor terminals 1 minute at 500VAC
Primary and protective conductor terminals 1 minute at 1500VAC
Primary and secondary terminals 1 minute at 2300VAC
Primary terminals : power terminals : (L,N), alarm output
Secondary terminals : measuring input terminals, digital input terminals, communication terminals,
- Case assembly material :Front... Flame-resistant polycarbonate resin (frame)
Case... Steel
- Case :Front...Black (Equivalent to Mussel N3.0)
Case...Gray (Equivalent to Mussel N7.0)
- Weight :2.1kg
- Mounting :Panel mounting
- Terminal screws :protective conductor...M4.0
Measuring input terminals, alarm output terminals,digital input terminals, ...M3.5
Communication terminals ...M3.0
- Clock accuracy :±2 minutes / 30 days (excluding errors due to power ON / OFF under the reference operating conditions)

Standards

- EMC Directive :EN61326-1 classA (CE, UKCA)
- *The indication equivalent to ±1mV may vary under the test environment by EMC directives.
- Low voltage directive:EN61010-1 (CE, UKCA)
EN61010-2-030 compliant (CE, UKCA)
Over voltage category II , Pollution Degree 2
Transient overvoltage: 2500V
Environment directives: RoHS (CE, UKCA)
EN IEC63000 complaint
(Monitoring and control equipment, including industrial devices)
Dust / splash proof :IEC60529 IP54(Front)

Option specifications

Options	Specifications
Alarm output	Mechanical relay (c contact) output for alarm activation and input error Output points :4 or 2 points Contact capacity : resistive load 3A, inductive load 1.5A (Maximum voltage 240 VAC or 30V DC)
Digital input Non voltage contact input (4 or 2 points)	ON/OFF Signal ON/OFF input recording
	Pulse input Maximum 10Hz pulse input Used for flow rate, operation time and frequency
External drive	Following operations are available (Selectable by parameter) • Data memory trigger • Marker display • Integrated calculation reset
	Communication interface for high and low order RS-485(MODBUS) Can be used by choosing one function from following 4 functions • Communication interface for high order unit • Low order instrument communication communication details specification method) Communication with MODBUS-RTU complaint instrument is possible by specifying lower order instrument communication • Low order instrument communication (Device selection method) Displaying and recording of input data of devices connected to the lower level, recording data in PLC registers and parameter settings, measured values, set values, etc. for up to 31 controllers is possible Recording points: 6 Point specifications ...34 points 12 Point specifications ...28 points Connectable models:KE,KR2S00,KR3S00, KR2000,KR3000, KR2D00,KR3D00,KR2-H,KR3-H,LE5000 AL4000,AH4000, DB600 DB1000,DB2000,KP1000,KP2000, DP-G (Data collection only), JU,JW,SE3000 • Transfer of KR2-H input data to PLC. Only PLC can be connected. Data writing points:44 points PLC that can be connected: Mitsubishi MELSEC ...AnA, QnA,QnAS,Q, FX series(1C frame only) Omron...SYSMAC Series Note) For connecting with Omron PLC , line convertor (sold separately) is required
High and low order communication	
Communication interface	
Lower order communication	Interface for lower order communication RS-232C • Bar code scanner Marker writing, group display switch over, batch operations can be performed depending on bar code scanned.
Ethernet	KR2-H can be connected to network using Ethernet (10BASE-T/100BASE-TX) This is required when using below functions • FTP server • FTP client • SNTP client • Web server • E-Mail • MODBUS TCP
Custom graphic screen	Creating graphic screen on PC and display to KR screen using CF card is possible by using KR Screen Designer (Option). Values measured by KR can be placed on the screen.
KT-M input	Digital communication (RS-485) with High Accuracy Temperature Converter KT-M
Portable type	Handle and rubber feet for easy carry

Accessories sold separately

Name	Capacity
Resistor for DC current input 100Ω	For 50mA
Resistor for DC current input 250Ω	For 20mA
SD card	512MB,1GB,2GB,8GB,32GB

Measuring ranges and accuracy

※FS= measuring range

Input type	Measuring range	Accuracy ratings	
DC Voltage	-13.80 ~ 13.80mV -27.60 ~ 27.60mV -69.00 ~ 69.00mV -200.0 ~ 200.0mV -500.0 ~ 500.0mV -2.000 ~ 2.000V	± 0.1%FS±1digit	
	(With built in voltage divider)		-5.000 ~ 5.000V -10.00 ~ 10.00V -20.00 ~ 20.00V -50.00 ~ 50.00V
T/C	K	-200.0 ~ 300.0°C -200.0 ~ 600.0°C -200 ~ 1370°C	± 0.1%FS±1digit * -200~0°C: ± 0.2%FS±1digit
	E	-200.0 ~ 200.0°C -200.0 ~ 350.0°C -200 ~ 900°C	
	J	-200.0 ~ 250.0°C -200.0 ~ 500.0°C -200 ~ 1200°C	
	T	-200.0 ~ 250.0°C -200.0 ~ 400.0°C	± 0.1%FS±1digit *0~ 400°C: ± 0.2%FS±1digit
	R	0 ~ 1200°C 0 ~ 1760°C	
	S	0 ~ 1300°C 0 ~ 1760°C	± 0.1%FS±1digit *0 ~ 400°C: ± 0.15%FS±1digit
	B	0 ~ 1820°C	
	N	-200.0 ~ 400.0°C -200.0 ~ 750.0°C -200 ~ 1300°C	± 0.15%FS±1digit *0~ 100°C: ± 4%FS±1digit * 100~400°C: ± 0.5%FS±1digit
	W-WRe26	0 ~ 2315°C	
	C(WRe5-WRe26)	0 ~ 2315°C	± 0.2%FS±1digit ± 0.2%FS±1digit *0~ 300°C: ± 1.5%FS±1digit * 300~800°C: ± 0.8%FS±1digit
	PtRh40-PtRh20	0 ~ 1888°C	
	NiMo-Ni	-50.0 ~ 290.0°C -50.0 ~ 600.0°C -50 ~ 1310°C	± 0.2%FS±1digit *0~ 20K: ± 0.5%FS±1digit *20~ 50K: ± 0.3%FS±1digit
	CR-AuFe	0.0 ~ 280.0K	
PlatinelII	0.0 ~ 350.0°C 0.0 ~ 650.0°C 0 ~ 1395°C	± 0.15%FS±1digit ± 0.15%FS±1digit * -200~0°C: ± 0.3%FS±1digit	
U	-200.0 ~ 250.0°C -200.0 ~ 500.0°C -200.0 ~ 600.0°C		
L	-200.0 ~ 250.0°C -200.0 ~ 500.0°C -200 ~ 900°C		
R T D	Pt100	-140.0 ~ 150.0°C -200.0 ~ 300.0°C -200.0 ~ 850.0°C	± 0.1%FS±1digit * -140.0~150.0°C, 700~850°C: ± 0.15%FS±1digit
	JPt100	-140.0 ~ 150.0°C -200.0 ~ 300.0°C -200.0 ~ 649.0°C	
	Pt50	-200.0 ~ 649.0°C	± 0.15%FS±1digit *4~ 50K: ± 0.3%FS±1digit
	Pt-Co	4.0 ~ 374.0K	

Note : The accuracy ratings are converted in to the measuring range under reference operating condition. Thermocouple input does not contain reference junction compensation accuracy.
 K,E, J, T, R, S, B, N:IEC584, JIS C1602-1995
 W-WRe26,PtRh40-PtRh20, Platinel II, NiMo-Ni, Cr-AuFe:ASTM Vol14.03
 C(WRe5-WRe26):JIS C1602-2015
 U(Cu-CuNi), L (Fe-CuNi):DIN43710
 Pt100:IEC751 (1995), JIS C1604-2013,
 JPt100:JIS C1606-1989, JIS C1604-1981
 Pt50:JIS C1604-1981

Application software

Integrated application software "TRAMS"

TRAMS can be connected to our recorders, controllers, setting units and PC and operations like parameter settings, data recording and data analysis can be performed.

Analysis function

This software is used to play back and display data files collected by KR2-H series recorder and to perform waveform processing and editing. In addition to playback and display of vertical and horizontal trends, the software has analysis functions like partial graph magnification and message insertion.

Display

Trend screen (Vertical flow)

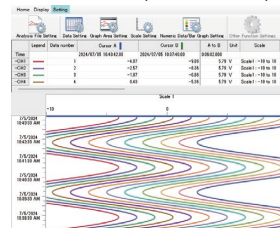

Trend screen (Horizontal flow)

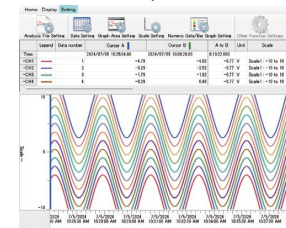

Main functions

- Trend display
Trend display (vertical flow), trend display (horizontal flow) is selectable
- Data list display
Recorded data is list displayed
- Bar graph
stacked graph
- Numerical data
All / Maximum value / minimum value / Average value / Standard deviation / Median value / can be displayed in list
- Alarm
Alarm activation status of various levels of numerical data
- Various settings
Trend screen, scale axis, time axis, analysis file title input
- Data conversion function
Export to EXCEL, CSV and TEXT file is possible
- Parameter setting function
Online settings of various parameters, saving and changes in parameter file is possible
- Recording function
Online collection of data and play back of collected data is possible

Operating environment

CPU	1GHz or more 32bit or 64bit
OS	Microsoft Windows 10 (32bit/64bit) Microsoft Windows 11 (64bit) *.NET Framework4.7.2 or above should be able to be installed
memory	1GB or above(32bit), 2GB or more (64bit)
Hard disk	2GB or more free disk space
Language	Japanese, English, Korean

※Display language mentioned is for PC and device is not included

Accessories

Name	Quantity	Details
① User manual	1	INE-952□[General] INE-883□[Communication] *CD-ROM PDF chart output software, Recipe creation software sample
	1	KR3S-02-□(Wiring and installation) *A4 Booklet
② Mounting brackets	2NOS	For panel mounting
③ Terminal screws	5NOS	M3.5 for measuring input terminals (Spare)
④ SD Card	1	RZ-SMC-512(512MB)

Terminal arrangement

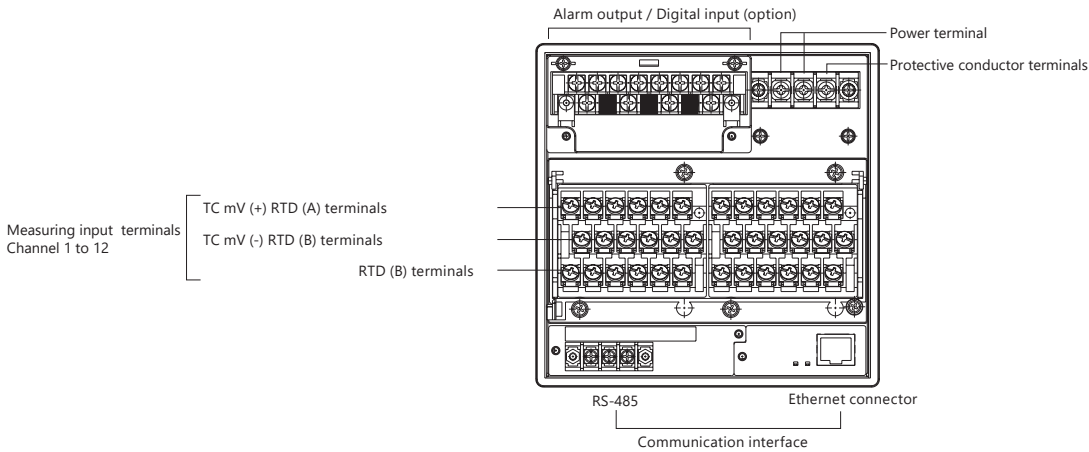

- Alarm relay output (4 points 'c' contact) (option)

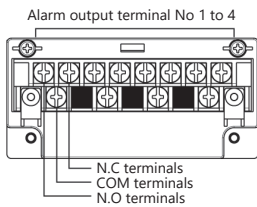

- Digital input (No voltage contact input 4 points)

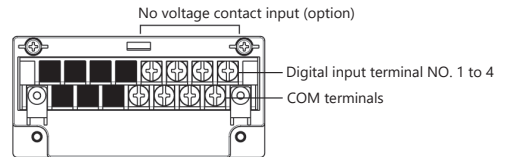

- Alarm relay output (2 points 'c' contact) + Digital input (No voltage contact input 2 points) (Option)

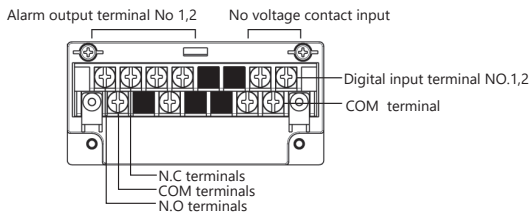

- Communication interface

Communication terminal block Ethernet+ High, low level communication (RS-485)

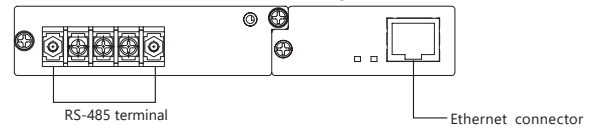

Communication terminal block Ethernet+ low level communication (RS-232C)

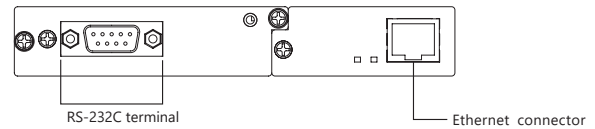

Dimension

- Panel mounting type

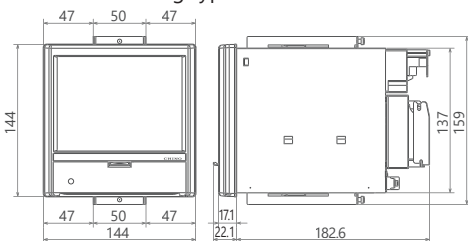

- Portable type (with handle and feet)

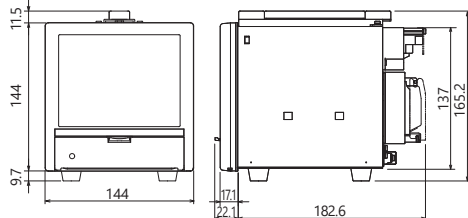

Panel cut out

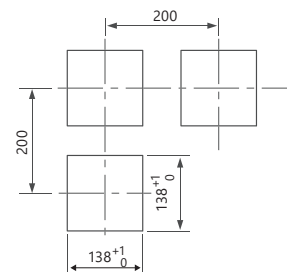

Unit:mm

Specifications subject to change without notice. 2024.7

CHINO CORPORATION

32-8 KUMANO-CHO,ITABASHI-KU,TOKYO 173-8632

Telephone : +81-3-3956-2171

Facsimile : +81-3-3956-0915

E-mail : inter@chino.co.jp

Website : www.chino.co.jp/